



Features

- High-density 1-megabit SRAM module
- High-speed CMOS SRAMs
— Access time of 20 ns
- 40-pin, 0.6-inch-wide DIP package
- Low active power
— 1.9W (max.)
- Hermetic SMD technology
- TTL-compatible inputs and outputs
- JEDEC-compatible pinout
- Commercial and military temperature ranges

Functional Description

The CYM1620 is a very high performance 1-megabit static RAM module organized as 64K words by 16 bits. The module is constructed using four 32K x 8 static RAMs mounted onto a substrate. A decoder is used to interpret the higher-order address A₁₅ and select one of the two pairs of RAMs.

Writing to the memory module is accomplished when the chip select (\overline{CS}), byte select (\overline{UB} , \overline{LB}) and write enable (\overline{WE}) inputs are both LOW. Data on the input/output pins of the selected byte (I/O₈ through I/O₁₅, I/O₀ through I/O₇) is written into

the memory location specified on the address pins (A₀ through A₁₅).

Reading the device is accomplished by taking chip select (\overline{CS}), byte select (\overline{UB} , \overline{LB}) and output enable (\overline{OE}) LOW, while \overline{WE} remains inactive or HIGH. Under these conditions, the contents of the memory locations specified on the address pins will appear on the appropriate data input/output pins.

The input/output pins remain in a high-impedance state when chip select (\overline{CS}), byte select (\overline{UB} , \overline{LB}) or output enable (\overline{OE}) is HIGH, or write enable (\overline{WE}) is LOW.

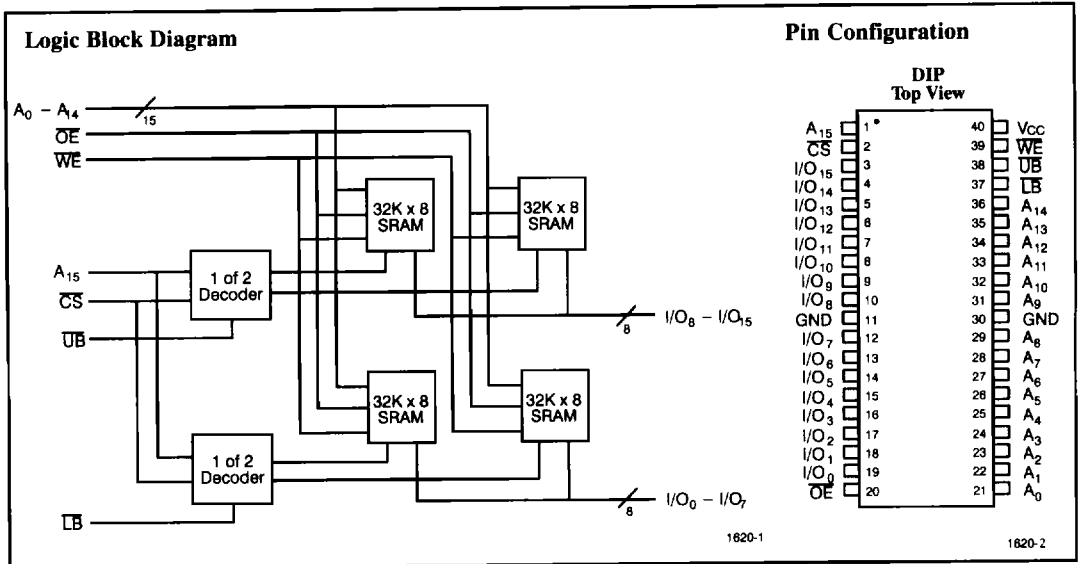

Selection Guide

		1620-20	1620-25	1620-30	1620-35	1620-45	1620-55
Maximum Access Time (ns)		20	25	30	35	45	55
Maximum Operating Current (mA)	Commercial	340	340	340	340	340	340
	Military			340	340	340	340
Maximum Standby Current (mA)	Commercial	140	140	140	140	140	140
	Military			140	140	140	140

Shaded area contains preliminary information.

Maximum Ratings

(Above which the useful life may be impaired.)

- Storage Temperature - 65°C to +150°C
- Ambient Temperature with Power Applied (Commercial) -10°C to +55°C (Military) -55°C to +125°C
- Supply Voltage to Ground Potential - 0.5V to +7.0V
- DC Voltage Applied to Outputs in High Z State - 0.5V to +7.0V
- DC Input Voltage - 0.5V to + 7.0V
- Output Current into Outputs (LOW) 20 mA

Operating Range

Range	Ambient Temperature	V _{CC}
Commercial	0°C to + 70°C	5V ± 10%
Military	-55°C to +125°C	5V ± 10%

Electrical Characteristics Over the Operating Range

Parameters	Description	Test Conditions	1620		Units
			Min.	Max.	
V _{OH}	Output HIGH Voltage	V _{CC} = Min., I _{OH} = -4.0 mA	2.4		V
V _{OL}	Output LOW Voltage	V _{CC} = Min., I _{OL} = 8.0 mA		0.4	V
V _{IH}	Input HIGH Voltage		2.2	V _{CC}	V
V _{IL}	Input LOW Voltage		-0.5	0.8	V
I _{IX}	Input Load Current	GND ≤ V _I ≤ V _{CC}	-10	+10	µA
I _{OZ}	Output Leakage Current	GND ≤ V _O ≤ V _{CC} , Output Disabled	-10	+10	µA
I _{OS}	Output Short Circuit Current ^[1]	V _{CC} = Max., V _{OUT} = GND		-300	mA
I _{CCx16}	V _{CC} Operating Supply Current	V _{CC} = Max., I _{OUT} = 0 mA, CS, UB, and LB = V _{IL}		340	mA
I _{CCx8}	V _{CC} Operating Supply Current	V _{CC} = Max., I _{OUT} = 0 mA, CS ≤ V _{IL} , UB or LB = V _{IL}		200	mA
I _{SB1}	Automatic CS Power-Down Current ^[2]	Max. V _{CC} ; CS ≥ V _{IH} Min. Duty Cycle = 100%		140	mA
I _{SB2}	Automatic CS Power-Down Current ^[2]	Max. V _{CC} ; CS ≥ V _{CC} - 0.3V, V _{IN} ≥ V _{CC} - 0.3V or V _{IN} ≤ 0.3V		80	mA

Capacitance^[3]

Parameters	Description	Test Conditions	Max.	Units
C _{IN}	Input Capacitance	T _A = 25°C, f = 1 MHz, V _{CC} = 5.0V	35	pF
C _{OUT}	Output Capacitance		40	pF

Notes:

1. Not more than 1 output should be shorted at one time. Duration of the short circuit should not exceed 30 seconds.
2. A pull-up resistor to V_{CC} on the CS input is required to keep the device deselected during V_{CC} power-up, otherwise I_{SB} will exceed values given.
3. Tested on a sample basis.

AC Test Loads and Waveforms

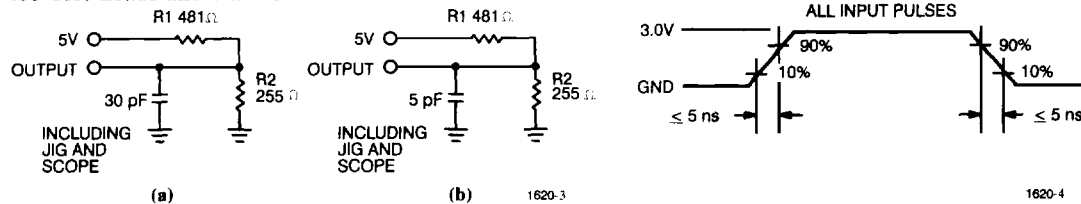

Equivalent to: THEVENIN EQUIVALENT

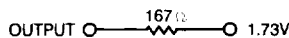

Switching Characteristics Over the Operating Range⁴⁾

Parameters	Description	1620-20		1620-25		1620-30		Units
		Min.	Max.	Min.	Max.	Min.	Max.	
READ CYCLE								
t _{RC}	Read Cycle Time	20		25		30		ns
t _{AA}	Address to Data Valid		20		25		30	ns
t _{OHA}	Data Hold from Address Change	3		3		3		ns
t _{ACS}	CS LOW to Data Valid		20		25		30	ns
t _{DOE}	OE LOW to Data Valid		10		10		15	ns
t _{LZOE}	OE LOW to Low Z	0		0		0		ns
t _{HZOE}	OE HIGH to High Z		10		10		20	ns
t _{LZCS}	CS LOW to Low Z ⁵⁾	3		3		5		ns
t _{HZCS}	CS HIGH to High Z ^{5), 6)}		20		20		20	ns
WRITE CYCLE⁷⁾								
t _{WC}	Write Cycle Time	20		25		30		ns
t _{SCS}	CS LOW to Write End	15		20		25		ns
t _{AW}	Address Set-Up to Write End	15		20		25		ns
t _{HIA}	Address Hold from Write End	2		2		5		ns
t _{SA}	Address Set-Up to Write Start	5		5		5		ns
t _{PWE}	WE Pulse Width	15		20		25		ns
t _{SD}	Data Set-Up to Write End	10		12		18		ns
t _{HD}	Data Hold from Write End	2		2		3		ns
t _{LZWE}	WE HIGH to Low Z ⁵⁾	0		0		5		ns
t _{HZWE}	WE LOW to High Z ^{5), 6)}	0	8	0	10	0	15	ns

Parameters	Description	1620-35		1620-45		1620-55		Units
		Min.	Max.	Min.	Max.	Min.	Max.	
READ CYCLE								
t _{RC}	Read Cycle Time	35		45		55		ns
t _{AA}	Address to Data Valid		35		45		55	ns
t _{OHA}	Data Hold from Address Change	3		5		5		ns
t _{ACS}	CS LOW to Data Valid		35		45		55	ns
t _{DOE}	OE LOW to Data Valid		18		25		30	ns
t _{LZOE}	OE LOW to Low Z	0		0		0		ns
t _{HZOE}	OE HIGH to High Z		20		20		25	ns
t _{LZCS}	CS LOW to Low Z ⁵⁾	3		5		5		ns
t _{HZCS}	CS HIGH to High Z ^{5), 6)}		20		20		25	ns
WRITE CYCLE⁷⁾								
t _{WC}	Write Cycle Time	35		45		55		ns
t _{SCS}	CS LOW to Write End	30		40		45		ns
t _{AW}	Address Set-Up to Write End	30		40		45		ns
t _{HIA}	Address Hold from Write End	5		5		5		ns
t _{SA}	Address Set-Up to Write Start	5		5		5		ns
t _{PWE}	WE Pulse Width	25		25		30		ns
t _{SD}	Data Set-Up to Write End	18		20		25		ns
t _{HD}	Data Hold from Write End	3		5		5		ns
t _{LZWE}	WE HIGH to Low Z ⁵⁾	5		5		5		ns
t _{HZWE}	WE LOW to High Z ^{5), 6)}	0	15	0	15	0	25	ns

Switching Waveforms^[10]

Read Cycle No. 1^[8, 9]

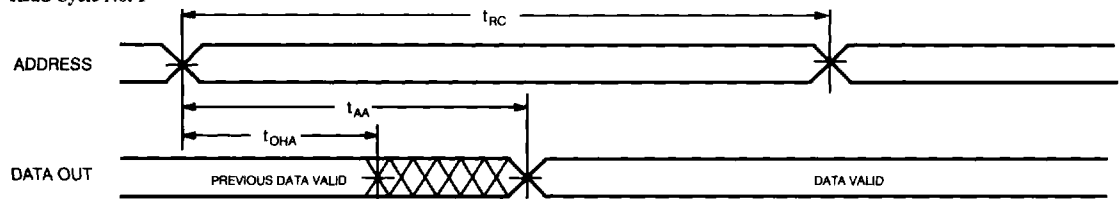

1620-5

Read Cycle No. 2^[8,10]

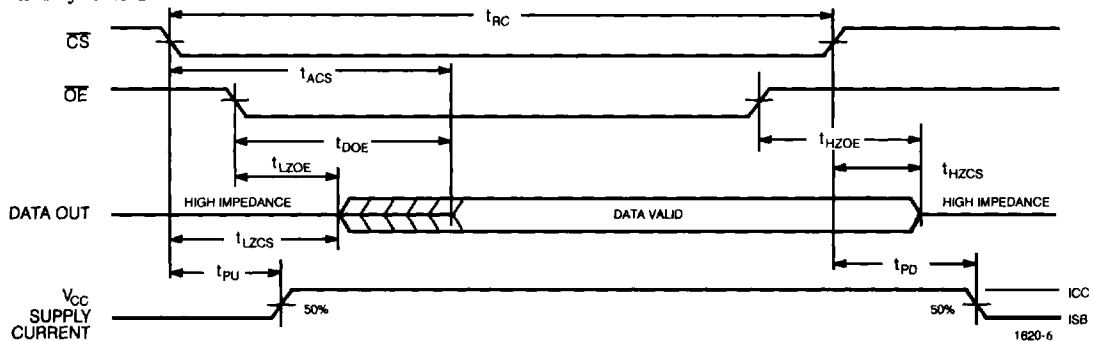

1620-6

Write Cycle No. 1 (WE Controlled)^[7, 11]

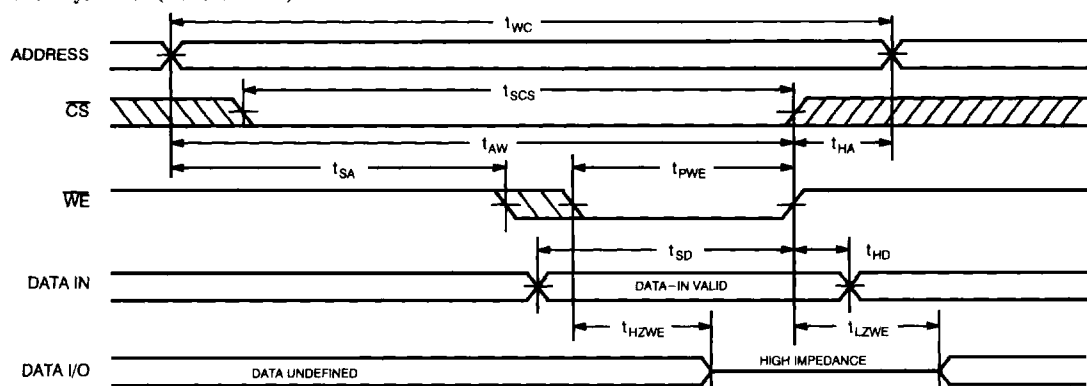

1620-7

Notes:

4. Test conditions assume signal transition times of 5 ns or less, timing reference levels of 1.5V, input levels of 0 to 3.0V, and output loading of the specified I_{OL}/I_{OH} and 30-pF load capacitance.
5. At any given temperature and voltage condition, t_{HZCS} is less than t_{LZCS} for any given device. These parameters are guaranteed and not 100% tested.
6. t_{HZCS} and t_{HZWE} are specified with $C_L = 5$ pF as in part (b) of AC Test Loads. Transition is measured ± 500 mV from steady state voltage.
7. The internal write time of the memory is defined by the overlap of \overline{CS} LOW and \overline{WE} LOW. Both signals must be LOW to initiate a write, and either signal can terminate a write by going HIGH. The data input

set-up and hold timing should be reference to the rising edge of the signal that terminates the write.

8. \overline{WE} is HIGH for read cycle.
9. Device is continuously selected, $\overline{CS} = V_{IL}$ and $\overline{OE} = V_{IL}$.
10. Address valid prior to or coincident with \overline{CS} transition LOW.
11. Data I/O will be high impedance if $\overline{OE} = V_{IH}$.
12. If \overline{CS} goes HIGH simultaneously with \overline{WE} HIGH, the output remains in a high-impedance state.

Switching Waveforms (continued)

Write Cycle No. 2 (\overline{CS} Controlled) [7, 8, 12]

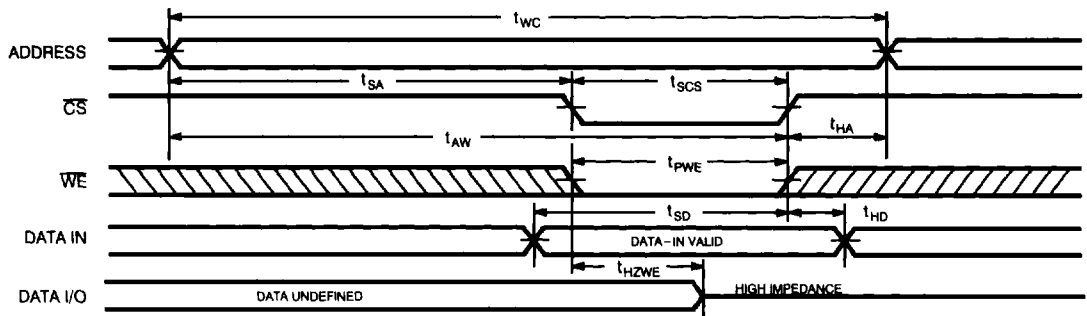

1620-8

Truth Table

\overline{CS}	\overline{UB}	\overline{LB}	\overline{OE}	\overline{WE}	Inputs/ Outputs	Mode
H	X	X	X	X	High Z	Deselect/ Power-Down
L	H	H	X	X	High Z	Deselect/ Power-Down
L	L	L	L	H	Data Out ₀₋₁₅	Read
L	H	L	L	H	Data In ₀₋₇	Read Lower Byte
L	L	H	L	H	Data Out ₈₋₁₅	Read Upper Byte
L	L	L	X	L	Data In ₀₋₁₅	Write
L	H	L	X	L	Data In ₀₋₇	Write Lower Byte
L	L	H	X	L	Data In ₈₋₁₅	Write Upper Byte
L	L	L	H	H	High Z	Deselect
L	H	L	H	H	High Z	Deselect
L	L	H	H	H	High Z	Deselect

Ordering Information

Speed (ns)	Ordering Code	Package Type	Operating Range
20	CYM1620PD-20C	PD04	Commercial
25	CYM1620PD-25C	PD04	Commercial
	CYM1620HD-25C	HD03	
30	CYM1620PD-30C	PD04	Commercial
	CYM1620HD-30C	HD03	
35	CYM1620PD-35C	PD04	Commercial
	CYM1620HD-35C	HD03	
	CYM1620HD-35MB	HD03	Military
45	CYM1620PD-45C	PD04	Commercial
	CYM1620HD-45C	HD03	
	CYM1620HD-45MB	HD03	Military
55	CYM1620PD-55C	PD04	Commercial
	CYM1620HD-55C	HD03	
	CYM1620HD-55MB	HD03	Military

Document #: 38-M-00008-C